

Installation manual

SWISSPACER AIR

SWISSPACER

The edge of tomorrow.

Table of Contents

List of figures	2
1 How the SWISSPACER AIR membrane works	3
2 Processing principles	3
3 Necessary materials / tools	5
4 Installation of the SWISSPACER AIR during manufacture of the multi-pane insulated glass unit (online)	8
4.1 Preparing the multi-pane insulated glass unit.....	8
4.2 Installing the SWISSPACER AIR	10
5 Installing the SWISSPACER AIR after the edge seal has hardened (offline)	13
5.1 Preparing the multi-pane insulated glass unit.....	13
5.2 Installing the SWISSPACER AIR	15

List of figures

Figure 1:	SWISSPACER AIR	3
Figure 2:	Placing the SWISSPACER AIR	13

1 How the SWISSPACER AIR membrane works

The SWISSPACER AIR is a metal sleeve with integrated special membrane which is integrated into the edge seal of the multi-pane insulated glass unit.



Figure 1: SWISSPACER AIR

The special structure of the SWISSPACER AIR prevents water vapour from being able to accumulate in the cavity between the panes, which would otherwise lead to the formation of condensation or damage the metallic Low-E coatings. The multi-pane insulated glass unit retains its function and quality over the long term through permanent pressure equalisation. A typical service life can thus be achieved for the multi-pane insulated glass unit – even in the presence of climatic loads.

2 Processing principles

The SWISSPACER AIR is screwed into the SWISSPACER spacer bar; once installed, the component may only penetrate the outer wall of the hollow profile.

The installation can be performed in two different ways:

- during manufacture of the multi-pane insulated glass unit (online)
- or
- afterwards in the hardened edge seal (offline).



A SWISSPACER AIR must be installed in each multi-pane insulated glass unit, choosing a position that is about 200 mm from the top corner of the multi-pane insulated glass unit (depending on the later installation position of the multi-pane insulated glass unit in the window).

Unlike when manufacturing a standard insulated glass unit, a pressure-equalised multi-pane insulated glass unit is not filled with a noble gas because the gas can escape through the component. The multi-pane insulated glass unit fitted with the SWISSPACER AIR is ready for transport, installation and use. It does not have to be sealed or worked on afterwards.

In triple-glazing units, one SWISSPACER AIR must be used for each gap between the panes.

2.1 Desiccant

Insulating glass made with SWISSPACER AIR must always be filled with molecular sieves on all four sides.

2.2 Cekal certification



On certified insulating glass lines according to Cekal, SWISSPACER AIR may only be installed offline with an already hardened edge seal.

2.3 Storage of insulating glass unit

Insulating glass units must generally be stored and transported protected from moisture. Especially in the case of glass packages stored outdoors, these should be covered with a foil to avoid direct contact with the SWISSPACER AIR.

3 Necessary materials / tools

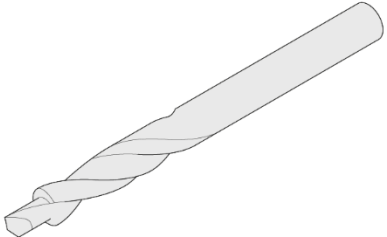
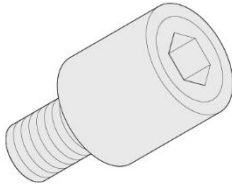
The following materials / tools are needed for the installation:

Designation	Article number	Figure
SWISSPACER step drill bit	Art. no.: 1650000000	
SWISSPACER AIR	Art. no.: 1600000000	
SWISSPACER O-ring	Art. no.: 1660000000	

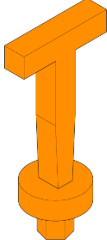
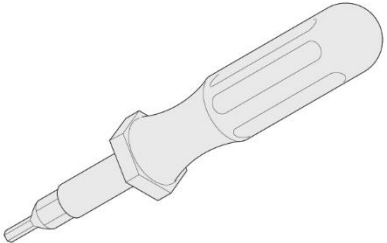
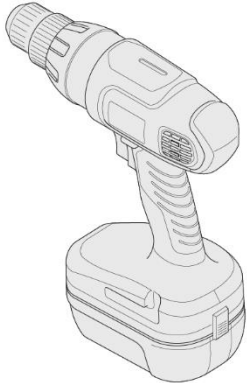
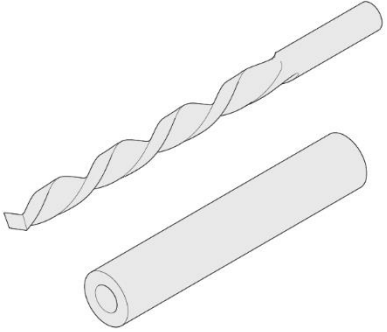
Designation	Article number	Figure
SWISSPACER AIR - plug		
SWISSPACER torque wrench	Art. no.: 1610000010	
Cordless screwdriver Optional: Sleeve as depth limiter for drilling the hole		
Drill bit (2.5 mm metal drill bit) with optional depth limiter		

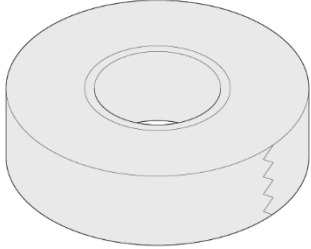
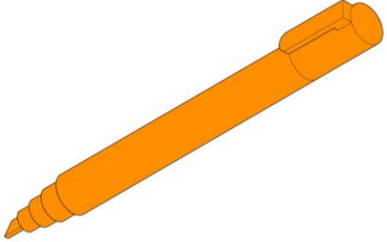
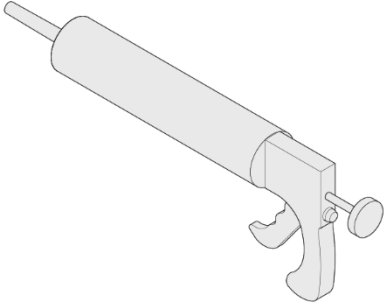
Designation	Article number	Figure
Adhesive tape (standard - insulating tape 15 mm width)		
Marker pen		
Sealant gun		

4 Installation of the SWISSPACER AIR during manufacture of the multi-pane insulated glass unit (online)

The SWISSPACER AIR can be installed during manufacture of the multi-pane insulated glass unit. The component is to be placed in one of the two vertical sides of the multi-pane insulated glass unit, about 200 mm from the top corner of the subsequent installation position of the multi-pane insulated glass unit in the window.

4.1 Preparing the multi-pane insulated glass unit

Preparing the multi-pane insulated glass unit consists of the following steps:



In order to be able to install the SWISSPACER AIR in the spacer bar, its position in the multi-pane insulated glass unit must not be filled with sealant.

1. After the pressing procedure, apply a length of adhesive tape to the installation position (about 200 mm below the top corner of a vertical side).

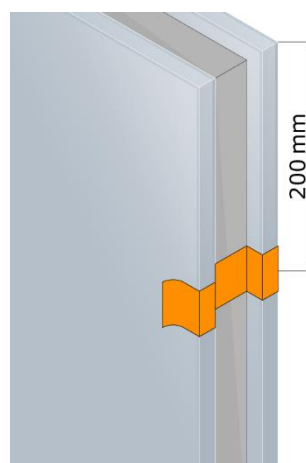

Stick the adhesive tape across the entire edge of the multi-pane insulated glass unit (over both gaps between the panes in triple-glazing units).

It is important that the tape adheres to the spine of the spacer bar.

1. Now automatically seal the multi-pane insulated glass unit with secondary sealant in the regular production process.

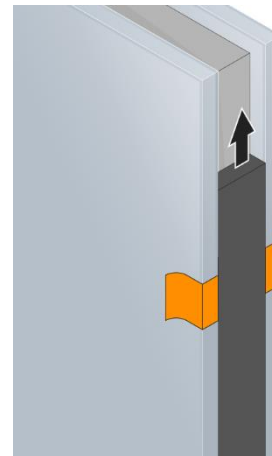

During the planning stage, ensure that the sealant height (edge coverage) is at least 4.5 mm, so that the SWISSPACER AIR does not protrude above the sealant.

2. Immediately after sealing the edge of the multi-pane insulated glass unit, carefully remove and dispose of the adhesive tape.

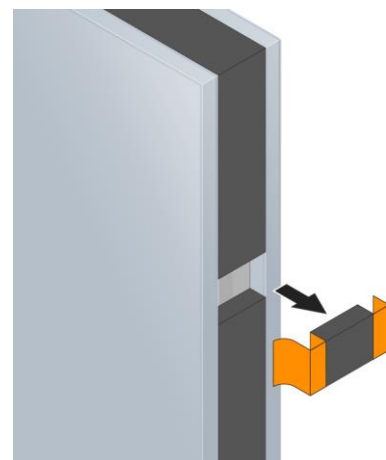

4.2 Installing the SWISSPACER AIR

Installing the SWISSPACER AIR consists of the following steps:

1. Drill centrally through the spine of the spacer bar with a 2.5 mm diameter drill bit. Use a depth limiter (slipped-over sleeving) to prevent the inner wall of the spacer bar being damaged in the direction of the gap between the panes.

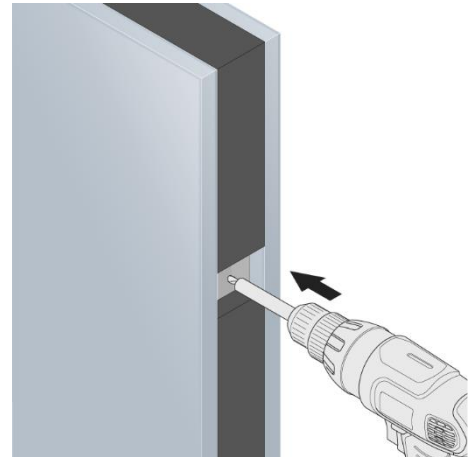

2. Place the supplied SWISSPACER O-ring over the thread of the SWISSPACER AIR to enable a tight installation.

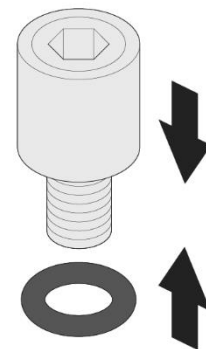

3. Place the SWISSPACER AIR on the bit of the torque wrench and position vertically over the drilled hole.

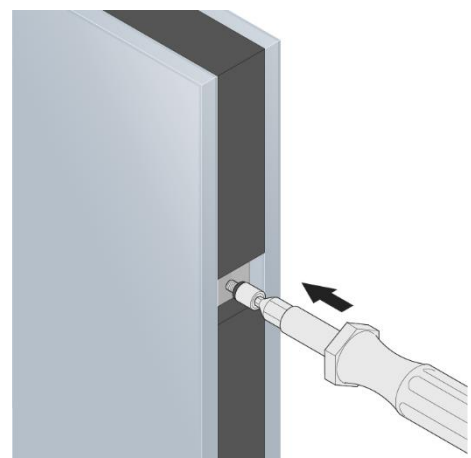

4. Screw in the SWISSPACER AIR at right-angles to the edge of the glass with a torque of 0.2 Nm.

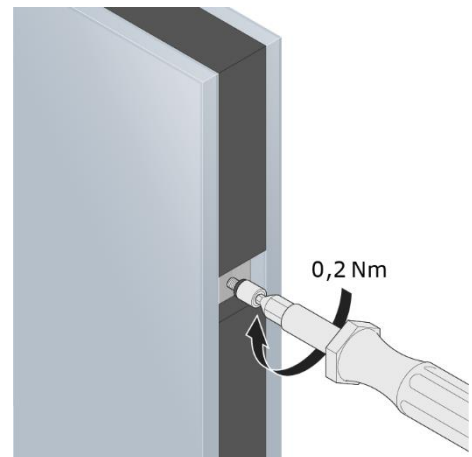

5. Close off the opening of the SWISSPACER AIR with the supplied plug. Then fill the cavity around the SWISSPACER AIR using a sealant gun and finally smooth the surface.

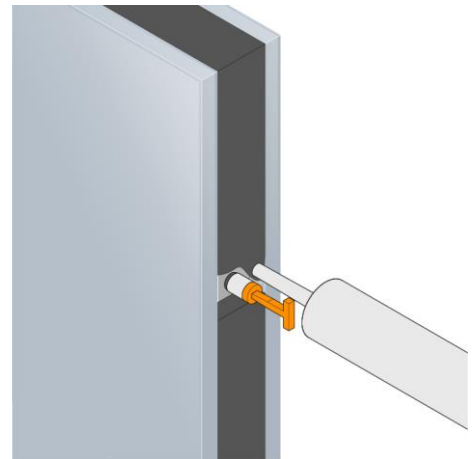

6. Leave the injected sealant to harden until the multi-pane insulated glass unit can be transported (approx. 3-4 hours).



7. Mark the position of the SWISSPACER AIR on the surface of the glass.

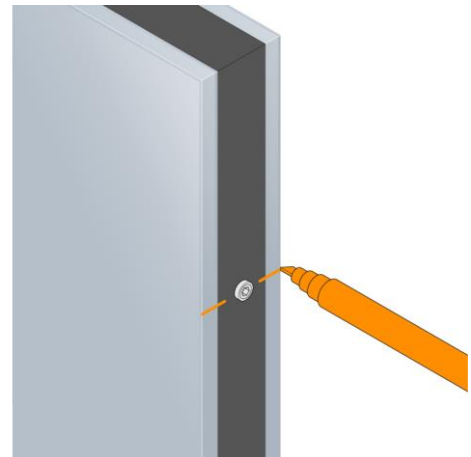

Important: SWISSPACER AIR must be screwed into the drilled hole as described in order to achieve a positive installation and to ensure proper function. Other installation methods (e.g. simply pushing the component into the drilled hole) are not permitted.

Subsequent removal and re-installation of a previously mounted SWISSPACER AIR is not possible as this could damage the membrane.

5 Installing the SWISSPACER AIR after the edge seal has hardened (offline)

The SWISSPACER AIR can be installed after the edge seal of the multi-pane insulated glass unit has hardened. The component is to be placed in one of the two vertical sides of the multi-pane insulated glass unit, about 200 mm from the top corner of the subsequent installation position of the multi-pane insulated glass unit in the window.

5.1 Preparing the multi-pane insulated glass unit

Once the sealant has hardened, the installation process can commence.



SWISSPACER AIR must be placed in one of the two vertical sides of the multi-pane insulated glass unit, about 200 mm below the top corner.

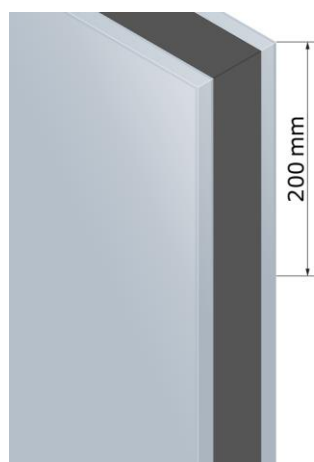

Figure 2: Placing the SWISSPACER AIR

Preparing the multi-pane insulated glass unit consists of the following steps:



Caution

Ensure that the drill bit is not inserted too deep. The inner wall of the spacer bar hollow profile must not be damaged. It is therefore recommended to use sleeving as a depth limiter for the drilling process.

1. Insert the SWISSPACER step drill bit into the cordless screwdriver.

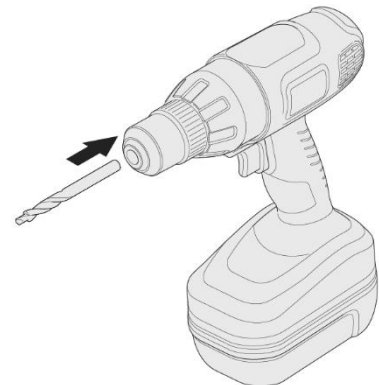

2. Place the SWISSPACER step drill bit centrally between the two panes and start drilling. The special geometry of the drill ensures quick and easy penetration into the sealant and into the outer wall of the spacer bar hollow profile.

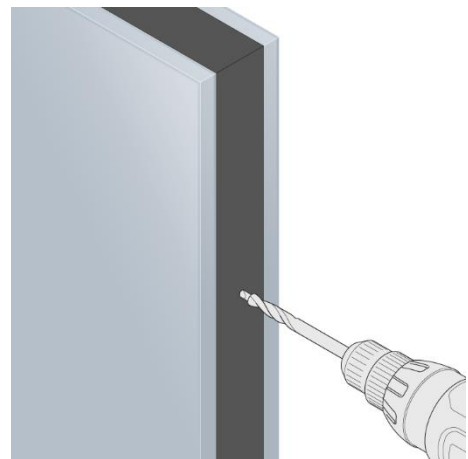

3. The sealant can be drilled through without applying any force. When the tip of the step drill bit reaches the spacer bar, a resistance will be felt that must be overcome.

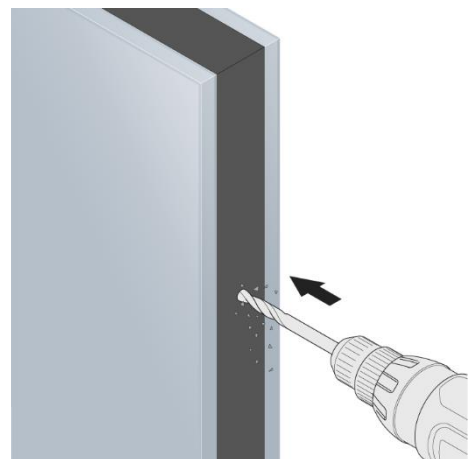

4. After completing the drilling process, clear the drilled hole of swarf and dust.
The multi-pane insulated glass unit is now prepared for installation of the SWISSPACER AIR.



5.2 Installing the SWISSPACER AIR

Installing the SWISSPACER AIR consists of the following steps:

1. Place the supplied O-ring over the thread of the SWISSPACER AIR to enable a tight installation.

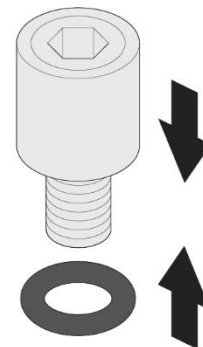

2. Place the SWISSPACER AIR on the bit of the torque wrench and position vertically over the drilled hole.

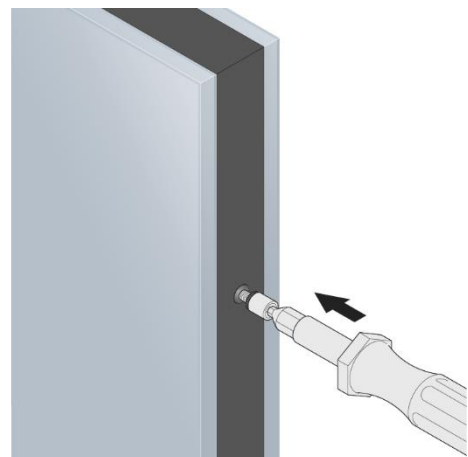

3. Screw in the SWISSPACER AIR at right-angles to the edge of the glass with a torque of 0.2 Nm.

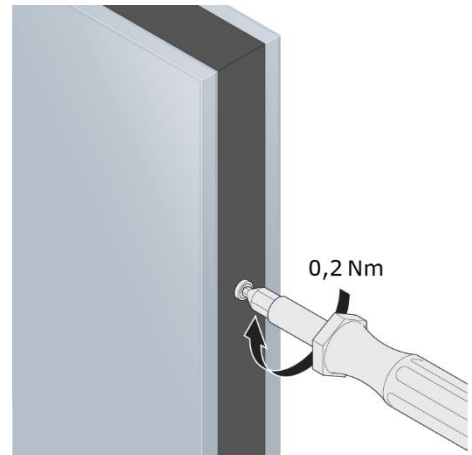

4. Mark the position of the SWISSPACER AIR on the surface of the glass.

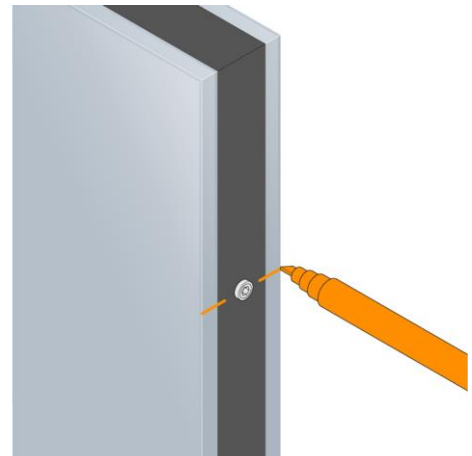

Important: SWISSPACER AIR must be screwed into the drilled hole as described in order to achieve a positive installation and to ensure proper function. Other installation methods (e.g. simply pushing the component into the drilled hole) are not permitted.

Subsequent removal and re-installation of a previously mounted SWISSPACER AIR is not possible as this could damage the membrane.



Instructions for using this installation manual

This installation manual is limited to the most important instructions for the processing of SWISSPACER spacer bars.

The instructions given are based on many years of practical experience and the latest knowledge.

The trading names of other companies mentioned in this document is for informational purposes only and does not preclude the use of other products of the same type.

We would be pleased to send you supplemental documents on individual areas on request.

If you have any questions, please contact us at:
technik@swisspacer.com

Copyright

All rights reserved. The duplication of photos, texts and data, including their storage and use on optical and electronic data carriers, is permitted only with the prior consent of Vetrotech Saint-Gobain (Int.) AG. The utilisation of data including their storage in online services, databases or websites by third parties is prohibited without permission.



Exclusion of liability

Vetrotech Saint-Gobain (Int.) AG is not liable for damage resulting from incorrect content or actions carried out in good faith as regards the correctness of the content. The application, use and processing of our products and of the products manufactured by you on the basis of our technical advice takes place outside our control and therefore solely within the scope of your responsibility.

The customer is not exempt from having the functions or applications of the products carefully checked by suitably qualified personnel.

Target group of the instructions: Manufacturers of insulated glass in a technical capacity

This version supersedes the validity of all prior versions.